

# American National Standard

## *Nomenclature for : Standard Steel Doors and Steel Frames*

---



SPONSOR  
**Steel Door Institute**

Approved February 6, 1997

 **ANSI** American National Standards Institute  
11 West 42nd Street,  
New York, New York  
10036

**ANSI®**  
**A250.7-1997**

**American National Standard  
Nomenclature for  
Standard Steel Doors and Steel Frames**

Secretariat

**Steel Door Institute**

Approved February 6, 1997  
**American National Standard**

# American National Standard

Approval of an American National Standard requires verification by ANSI that the requirements for due process, consensus, and other criteria for approval have been met by the standards developer.

Consensus is established when, in the judgement of the ANSI Board of Standards Review, substantial agreement has been reached by directly and materially affected interests. Substantial agreement means much more than a simple majority, but not necessarily unanimity. Consensus requires that all views and objections be considered, and that a concerted effort be made toward their resolution.

The use of American National Standards is completely voluntary; their existence does not in any respect preclude anyone, whether he has approved the standards or not, from manufacturing, marketing, purchasing, or using products, processes, or procedures not conforming to the standards.

The American National Standards Institute does not develop standards and will in no circumstances give any interpretation of any American National Standard. Moreover, no person shall have the right or authority to issue an interpretation of an American National Standard in the name of the American National Standards Institute. Requests for interpretations should be addressed to the secretariat or sponsor whose name appears on the title page of this standard.

**CAUTION NOTICE:** This American National Standard may be revised or withdrawn at any time. The procedures of the American National Standards Institute require that action be taken periodically to reaffirm, revise, or withdraw this standard. Purchasers of American National Standards may receive current information on all standards by calling or writing the American National Standards Institute.

Published by

**Steel Door Institute**  
**30200 Detroit Road, Cleveland, Ohio 44145-1967**

Copyright © 1997 by American National Standards Institute  
All rights reserved.

No part of this publication may be reproduced in any form, in an electronic retrieval system or otherwise, without prior written permission of the publisher.

Printed in the United States of America

**ANSI A250.7-1997**

# Contents

	Page
Foreword .....	ii
<b>1</b> Nomenclature for Steel Door Frames .....	<b>1</b>
<b>2</b> Nomenclature for Standard Steel Doors .....	<b>13</b>
<b>Charts</b>	
Door and Frame Handing Chart .....	12
Nomenclature for Standard Door Designs .....	21

**Foreword** (This Foreword is not part of the American National Standard  
Nomenclature for Standard Steel Doors and Steel Frames)

The material contained in this document has been developed under the auspices of the Technical Committee of the Steel Door Institute.

The current edition is a revision, and replaces, the ANSI Standard A123.1-1898 document with the contents being updated to reflect changes that have taken place in the steel door and frame industry since that time.

Suggestions for improvement gained in the use of this standard will be welcome. They should be sent to the American National Standards Institute, Inc. 11 West 42nd Street, New York, NY 10036.

The organizations that have approved this standard are as follows.

American Institute of Architects  
American Insurance Services Group, Inc.  
Architectural Woodwork Institute  
BOCA International  
Builders Hardware Mfrs. Assn.  
Door and Hardware Institute  
Factory Mutual Research Corporation  
General Services Administration  
Insulated Steel Door Institute  
International Conference of Building Officials  
Manufactured Housing Institute  
National Association of Architectural Metal Manufacturers  
National Association of Home Builders  
National Wood Window & Door Association  
Underwriters Laboratories Inc.

The Technical Committee of the Steel Door Institute, which has developed this Standard had the following personnel at the time of approval:

Stan Horsfall, *Chairman*  
Wendell Haney, *Vice Chairman*  
Bob Carnick, *2nd Vice Chairman*  
J.J. Wherry, *Managing Director*

<i>Organization Represented</i>	<i>Name of Representative</i>
Amweld Building Products Inc. ....	Allan Ashachik
Benchmark Commercial Doors .....	Wendell Haney
Ceco Door Products .....	Tom R. Janicak
Copco Door Company .....	Robert C. Carnick
Curries Company .....	Stan L. Horsfall
Deansteel Manufacturing Co. ....	Claus D. Heide
The Kewanee Corporation .....	Rose Cliff
Mesker Door Company .....	Tim Jarvis
Pioneer Industries .....	Gopal S. Kukke
Republic Builders Products .....	Craig Ordmandy
Steelcraft .....	Donald L. King
Steel Door Institute .....	J. J. Wherry

# Nomenclature for Standard Steel Doors and Steel Frames

## 1 Frames

### [ADJUSTABLE BASE ANCHOR]

a device used to anchor frames to a depressed slab or below finished floor line

### [ADJUSTABLE FRAME]

frame with profile in two or more pieces that will adjust to accommodate several wall thickness—also known as expandable frame

### [ANCHOR]

a device for attaching frame to the surrounding structure

### [APPLIED STOP]

surface mounted stop attached to a cased opening

### [APPLIED TRIM]

decorative piece applied onto the face of a frame

### [BACKBEND]

return leg member at back of frame profile

### [BACKBEND RETURN]

turned in edge of backbend

### [BARRIER SCREEN]

an archaic term—see *smoke barrier*

### [BASE]

see *sill*

### [BASE ANCHOR (CLIP)]

metal member attached to base of frame to secure frame to the floor, either fixed or adjustable

### [BASE ANCHOR EXTENSION]

metal angle attached to the base of frame with the horizontal leg extending beyond the frame backbend—used to facilitate the use of power tools in attachment of frame to floor

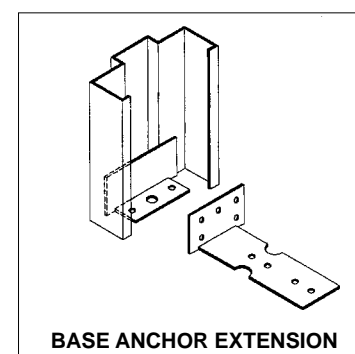
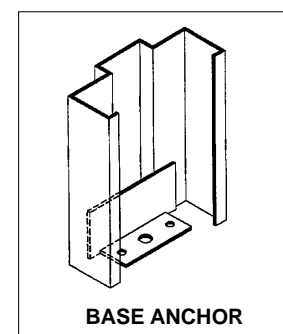
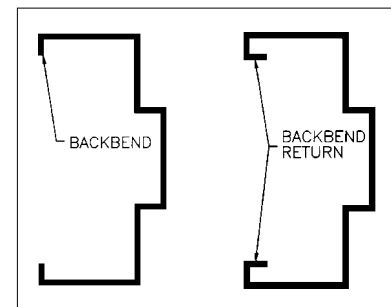
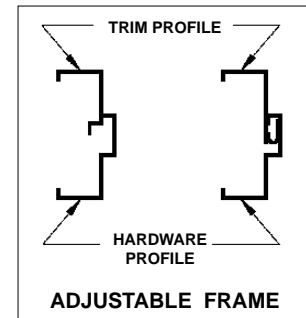

**ANSI A250.7-1997**

**[BLANK JAMB]**

vertical member of frame without hardware preparation—used when doors are furnished with push and pull hardware or surface mounted strikes and single or double acting floor hinges

**[BORROWED LITE]**

four-sided frame installed in an interior partition prepared for field installation of stationary (fixed) glazing

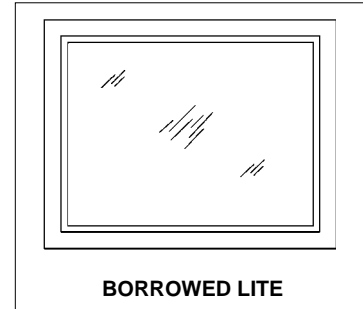

**[BUCK]**

an archaic term for a door frame

**[BUTTED FRAME]**

frame which fits against wall structure rather than around it—frame depth is normally equal to or less than the wall thickness

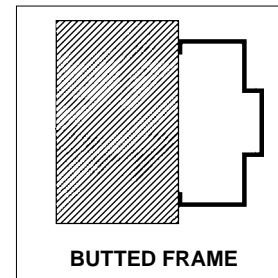

**[CABINET JAMB]**

frame in three or more pieces applied as the finished frame over rough buck—see *rough buck*

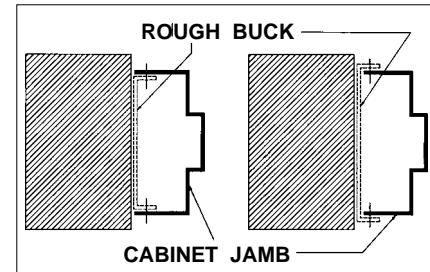

**[CASED OPENING]**

frame section without stops

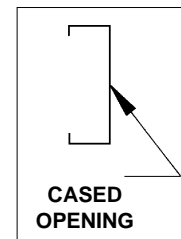

**[CEILING STRUT]**

adjustable vertical supporting member that extends from jamb or header to structure above normally used in wet plaster walls or as intermediate support for smoke barriers

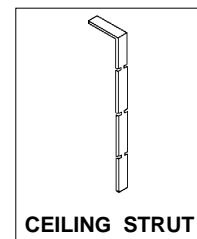

**[CLOSER REINFORCING (PARALLEL ARM)]**

reinforcing in soffit of frame header to provide additional strength for attachment of closer brackets

**[CLOSER REINFORCING (CORNER BRACKET)]**

reinforcing in soffit of frame header and jambs to provide additional strength for attachment of corner brackets

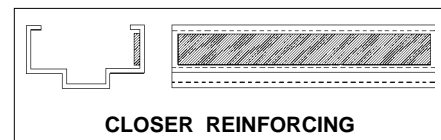

**[CLOSER REINFORCING (REGULAR ARM) (TOP JAMB)]**

reinforcing in face of frame header to provide additional strength for the attachment of door closer

**[CLOSER REINFORCING SLEEVE]**

formed plate inside frame header conforming to soffit, rabbet, and face profile to provide additional strength for door closer attachment

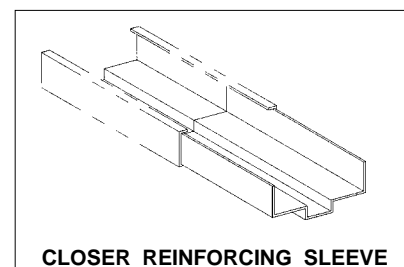

**[COMMUNICATING FRAME]**

Double rabbeted frame with both rabbets prepared for single-swing doors—doors swing in opposite directions—both doors may be of the same or opposite hand

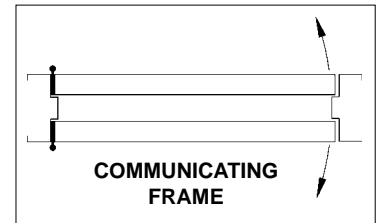
**[COMPLETED OPENING ANCHOR]**

see *existing wall anchor*

**[CONTINUOUS WELD]**

weld which is unbroken, no unwelded gaps or spaces, over its entire length

**[CORNER REINFORCEMENT (GUSSET)]**

reinforcing at junction of head and jambs used in interlocking of knock-down (K.D.) frames—may be used as alignment feature on welded frames

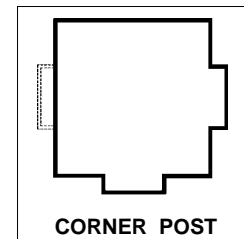
**[CORNER POST]**

vertical closed profile used at corner intersection of multiple elevation frames

**[CUTOFF STOP]**

see *terminated stop*

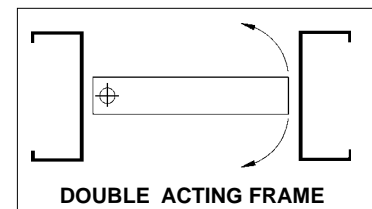
**[CUTOUT]**

a piercing in frame to accommodate a hardware item, mortised hardware or for other items

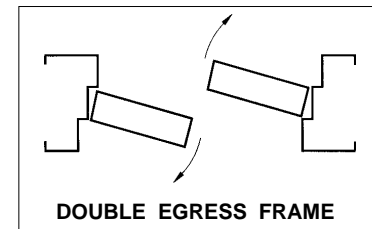
**[DEPTH]**

see *jamb depth*

**[DOUBLE ACTING FRAME]**

frame prepared for one or two double acting doors—cased opening frame is normally used

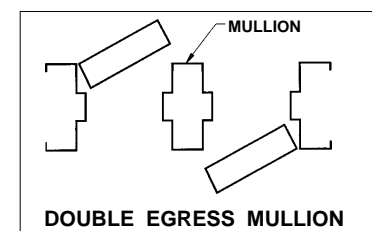
**[DOUBLE EGRESS FRAME]**

a double door frame prepared to receive two single-acting doors swinging in opposite directions—both doors to be of the same hand

**[DOUBLE EGRESS MULLION]**

mullion used to divide pairs of doors in some types of double egress frames

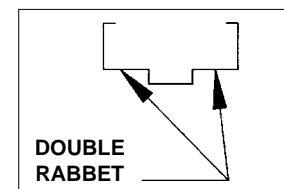
**[DOUBLE RABBET FRAME]**

frame having recesses capable of receiving doors on both sides of stop. Normally only one recess is prepared for a door

**[DOUBLE RETURN]**

see *backbend return*

**[DOUBLE SWING FRAME (PAIR SWING FRAME)]**

frame prepared for a pair of single-acting doors, both of which swing in the same direction

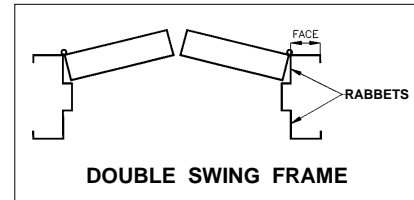

**[DRYWALL FRAME (BUILT-IN)]**

a frame with steel or wood studs anchors designed to be used in a steel stud or wood stud partition which is installed after the frame is set

**[DRYWALL FRAME (SLIP-ON)]**

frame designed to be installed on a wall composed of steel or wood studs with gypsumboard or other facing material not requiring wet plaster or masonry finishing—it is installed after the wall is erected

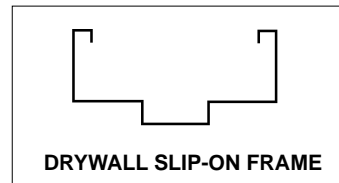

**[DUST COVER BOX]**

see *plaster guard*

**[DUTCH DOOR FRAME]**

frame prepared for *dutch* door

**[EXISTING WALL ANCHOR]**

metal piece inside throat of frame which provides necessary reinforcing when frame is secured in an existing wall using screws and expansion shields

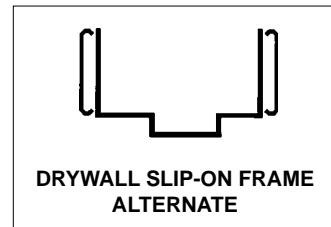

**[EXTENSION BELOW FLOOR]**

distance jamb pieces extend below finish floor to attach to sub floor

**[FACE]**

exposed part of frame when viewed perpendicular to face of the door also referred to as trim

**[FILLER PLATE]**

a blank plate used to fill mortised cutouts

**[FILLER SECTION]**

see *throat filler*

**[FIXED TRANSOM]**

inoperable panel or glass lite above door opening

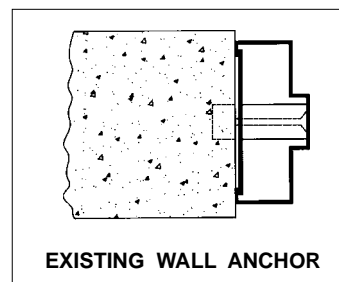

**[FLOOR ANCHOR (CLIP)]**

see *base anchor (clip)*

**[FLOOR ANCHOR EXTENSION]**

see *base anchor extension*

**[FLOOR CLEARANCE<sup>(1)</sup> (UNDERCUT)]**

clearance between bottom of frame and bottom of door

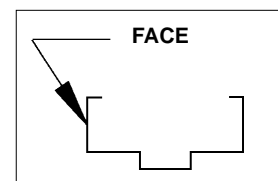

(1) The floor clearance described above may not be the same as the clearance between the bottom of the door and the finished floor. The floor clearance can only be determined after the finished floor material is in place

**[FLOOR STRUT]**

an archaic term—see *adjustable base anchor*

**[FRAME CLEARANCE]**

space between door and stop of frame—normally designed to accommodate rubber silencer

**[FRAME GASKET]**

strips (felt, sponge, rubber, etc.) used at frame stops or soffit for smoke, light, or weather protection

**[GASKETTED FRAME]**

a frame having gasket materials applied either directly to the stop, into a kerf, or part of an applied stop

**[GLAZING BEAD]**

removable trim at a glazed opening to hold glass securely in place

**[GROUTED FRAME]**

frame completely filled with mortar or plaster used in wall construction

**[HAND]**

term used to designate direction in which door swings

**[HARDWARE PROFILE]**

portion of adjustable frame or mullion onto which the door is normally attached

**[HEADER] [HEAD]**

horizontal frame member at top of opening or top member of transom frame

**[HEAD STIFFENER]**

A heavy gage angle or channel section placed inside of, and attached to, the head of a wide door frame to maintain its alignment—not to be used as a load-carrying member

**[HINGE BACKSET]**

distance from leading edge of hinge to stop on frame

**[HINGE FILLER PLATE]**

plate installed in hinge cutout when hinge is not required

**[HINGE JAMB]**

vertical member of frame prepared for installation of hinges

**[HINGE REINFORCEMENT]**

structure to which hinge is attached—used to provide adequate strength at preparation for hinge in frame

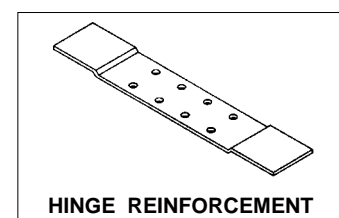
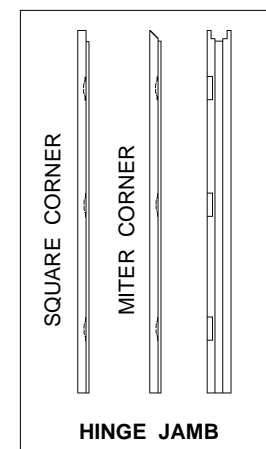
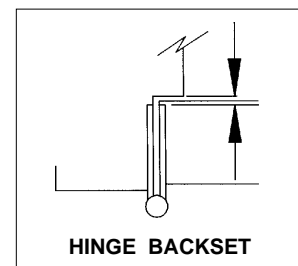
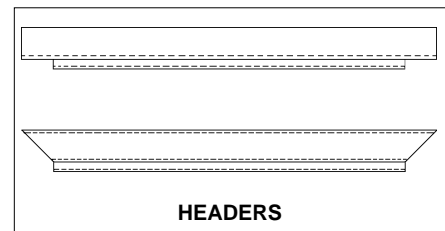
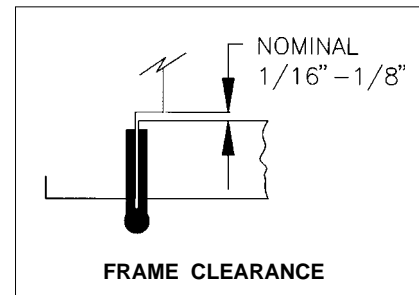

**ANSI A250.7-1997**

**[HOSPITAL STOP]**

see *terminated stop*

**[INTERCONNECTING FRAME]**

see *communicating frame*

**[IMPOST]**

see *mullion*

**[JAMB]**

a vertical member of the frame assembly, adjacent to wall

**[JAMB DEPTH]**

overall width of frame profile—face to face dimension

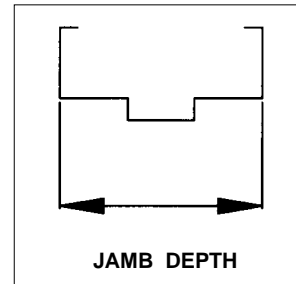

**[JAMB EXTENSION]**

see *extension below floor*

**[KERFED FRAME]**

a frame that is formed with an integral pocket or recess in the area of the stop to receive gasket or seals

**[KEYED-IN-FRAME]**

frame erected with plaster or mortar forced behind frame backbend— wall thickness is equal to or greater than frame throat, but no wider than frame depth

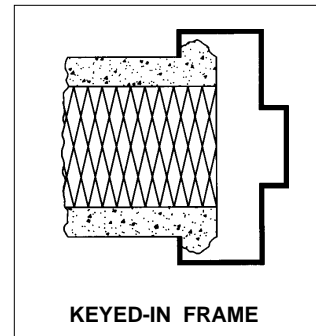

**[KNOCKED DOWN (KD) FRAME]**

door frame furnished by manufacturer in three or more basic parts for assembly in the field

**[LABELED FRAME]**

frame that conforms to all applicable requirements and procedures of governing labeling authority and bears their identification label or mark

**[LEAD LINED FRAME]**

frame internally covered with lead sheet to prevent radiation penetration

**[LOCK JAMB]**

see *strike jamb*

**[MASONRY ANCHOR (CLIP)]**

metal piece inside throat of frame which secures frame to masonry wall

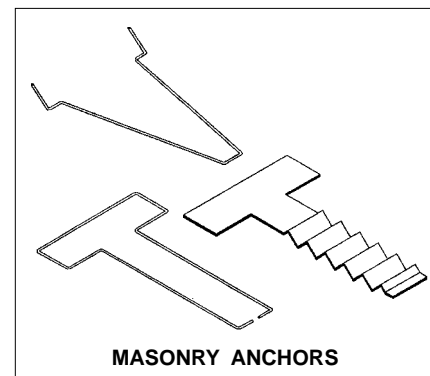

**[MASONRY BOX (GUARD)]**

see *plaster guard*

**[MODULAR FRAME]**

frame designed to fit a 4" module or unit of measurement

**[MORTISE]**

a recess on a minimum of 3 sides of the hardware item closely surrounding the contour of the item allowing its faceplate to finish flush with the frame surface

**[MORTISE PREPARATION]**

cutout, reinforcing, drilling and tapping for hardware which is to be mortised into frame

**[MULLION]**

tubular member set in a double door opening which will allow both door leaves to be active—may be fixed or removable—a mullion may also occur between a door and a sidelite or as a vertical and/or horizontal member separating lites or panels

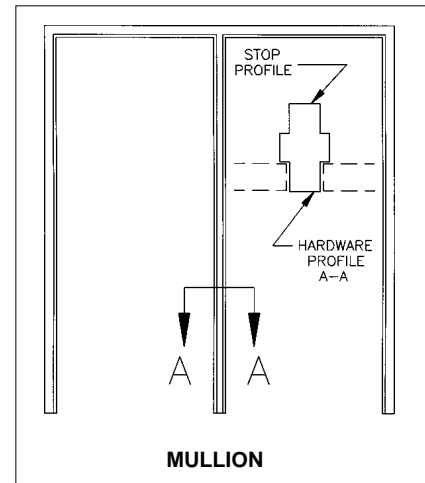
**[MUTE]**

see *rubber silencer*

**[NAIL ANCHORS (CLIPS)]**

see *wood stud anchor*

**[OPENING SIZE]**

size of frame opening measured between rabbets horizontally and between top rabbet and bottom of frame vertically

**[OPERABLE TRANSOM]**

panel or glass lite above door opening which may be opened for ventilation purposes

**[PLASTER GUARD]**

the shield attached behind hinge and strike reinforcement to prevent mortar or plaster from entering mounting holes

**[POCKET DOOR FRAME]**

frame designed to allow door to slide inside pocket in wall

**[PREPARED OPENING ANCHOR]**

see *existing wall anchor*

**[RABBET]**

the recess or offset formed in the frame to receive a door, panel, or glazing

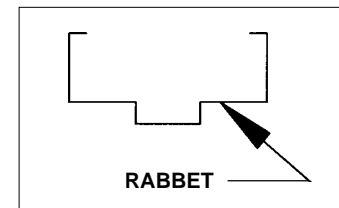
**[REMOVABLE MULLION]**

a mullion which can be temporarily taken out of opening to allow the passage of large objects through the opening—it may be a frame or hardware member

**[REMOVABLE STOP]**

stop which is removable to allow installation of glass, fixed panel, or door

**[RETURN]**

see *backbend*

**[REVEAL (FRAME)]**

the distance from the face of the frame to the face of the finished wall

**[ROUGH BUCK]**

a sub-frame, usually channel shaped, attached to an existing wall to which the finished frame is attached—see *cabinet jamb*

**[ROUGH OPENING]**

size of wall opening into which frame is to be installed

**[RUBBER SILENCER (MUTE) (BUMPER)]**

a part attached to the stop on a frame to cushion the closing of a door

**[SANITARY STOP]**

see *terminated stop*

**[SECTION WIDTH]**

see *jamb depth*

**[SIDELITE]**

same as borrowed lite except that it is attached to door frame

**[SILENCER]**

see *rubber silencer*

**[SILL (FRAME)]**

bottom horizontal member of borrowed lite or sidelite

**[SILL ANCHOR (CLIP)]**

part used to fasten sill section to floor

**[SINGLE RABBET FRAME]**

frame having only one rabbet—usually used with narrow jamb depths

**[SINGLE SWING FRAME]**

frame prepared for one swing door

**[SLEEVE REINFORCEMENT]**

see *closer reinforcing sleeve*

**[SLIP-ON FRAME]**

see *dry wall frame*

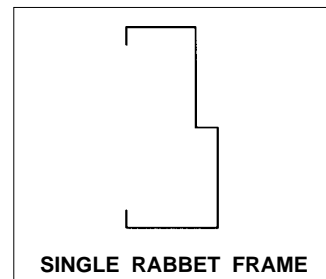
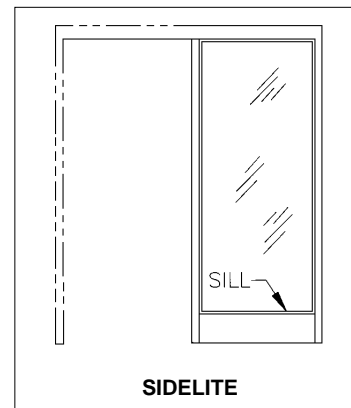
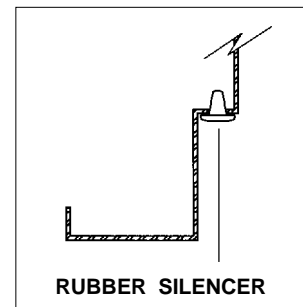
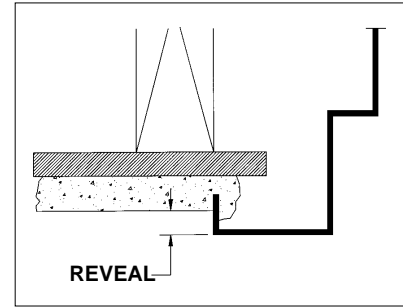

**[SMOKE BARRIER]**

a door frame combined with sidelites on either or, both sides of door openings, including transom openings when and if required

**[SOFFIT]**

the portion of the frame between stops on a double rabbeted frame and the stop and the largest face on a single rabbeted frame

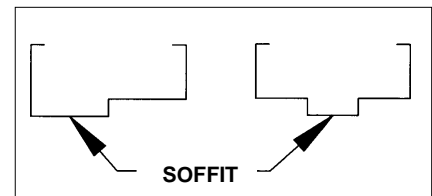
**[SOLID PLASTER ANCHOR (CLIP)]**

metal piece attached to inside throat of frame which secures frame to core section of a solid plaster wall—an archaic construction method

**[SPACER]**

rigid plastic member added to returns of dry-wall frame to provide additional wall thickness flexibility

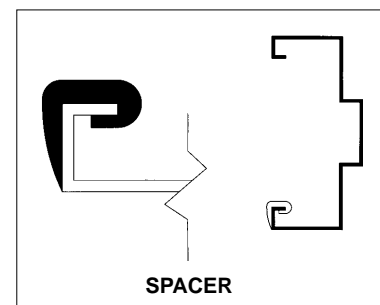
**[SPAT]**

protective covering (usually stainless steel) wrapped around bottom of frames to prevent or minimize damage in this area

**[SPLIT FRAME]**

a multi-piece frame which generally requires that a portion of the frame be installed from each side of the opening—see *adjustable frame*

**[SPREADER BAR]**

stiffening member placed at base of welded frame to keep frame in alignment during assembly, transportation and handling—not to be used for installation—reference SDI-105 and ANSI/DHI A115IG

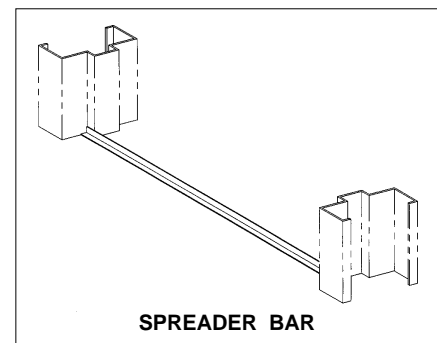
**[STEEL STUD ANCHOR (CLIP)]**

metal piece inside throat of frame used to secure frame to steel stud

**[STICKS]**

linear lengths of frame sections used for fabrication of transom/sidelite frames

**[STIFFENER]**

welded in member applicable on some drywall slip-on frame designs to reinforce jambs

**[STILT]**

an archaic term—see *floor strut*

**[STILT BASE ANCHOR]**

a device used to hold the bottom of frames above finished floorline—commonly used with terrazzo base—bottom of frame is above finished floor line

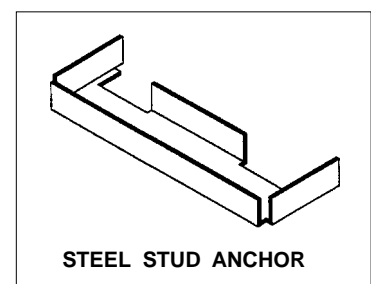

**[STOP]**

part of frame against which door closes

**[STOP PROFILE]**

the non hardware portion of the mullion

**[STRIKE JAMB]**

vertical member of frame prepared for installation of lock strike

**[STRIKE PREPARATION]**

cutout, machining and reinforcing in frame or inactive leaf door for strike—see ANSI A115

**[STRIKE REINFORCEMENT]**

structure to which strike is attached—used to provide additional strength at preparation for strike in frame

**[STRUT]**

see *ceiling strut*

**[STRUT GUIDE]**

metal piece attached inside throat of frame which guides and holds ceiling strut to frame (usually incorporated in anchor)

**[SUB BUCK]**

see *rough buck*

**[SUB FRAME]**

see *rough buck*

**[SURFACE HARDWARE REINFORCING]**

factory reinforcing of frame for field applied surface hardware—does not include drilling and tapping of mounting holes

**[SWING]**

handing of frame when viewed from stop side—e.g. RH swing frame is hinged on right hand jamb

**[TERMINATED STOP]**

a stop which terminates above floor line and is closed with a 45° or 90° angle

**[THRESHOLD]**

a raised finish hardware member extending between the jambs of a frame at the floor

**[THROAT FILLER]**

flat section generally with offset edges, used to close frame section throat opening

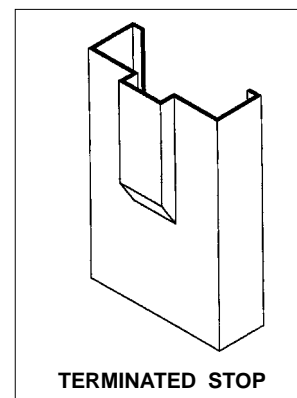
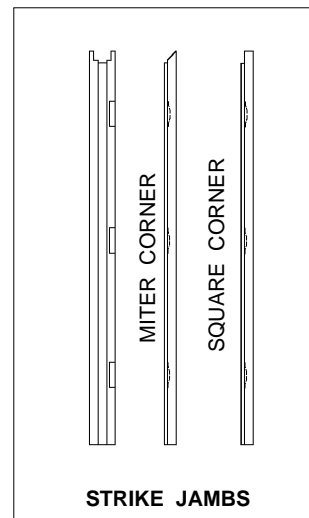
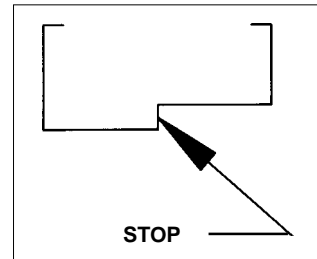

**[THROAT OPENING]**

opening between backbends of frame

**[TRANSOM]**

a frame area immediately above a door opening and containing fixed glass, an operating sash, panel or other filler

**[TRANSOM BAR]**

that part of a transom frame which separates the door area portion from the transom area portion

**[TRANSOM FRAME]**

door frame having a panel, louver, sash or glass above door opening with or without transom bar

**[TRANSOM PANEL]**

a panel installed in a frame above the door opening

**[TRIM]**

see *face*

**[TRIMED OPENING]**

see *cased opening*

**[TRIM PROFILE]**

the non hardware portion of an adjustable or split frame

**[WEATHERSTRIPPING]**

a seal used around the door opening for smoke, light, sound, or weather protection—see *frame gasket*

**[WELDED FRAME]**

door frame assembled by spot and/or arc welding at corners

**[WELDED-ON HINGE]**

hinge which has one leaf welded to inside of hinge rabbet in lieu of mortise preparation

**[WOOD STUD ANCHOR (CLIP)]**

metal piece inside throat of frame used to secure frame to wood stud

**[WRAP-AROUND FRAME]**

a frame which fits over the wall—the frame throat opening is nominal 1/8" more than wall thickness except at slip-on drywall frames

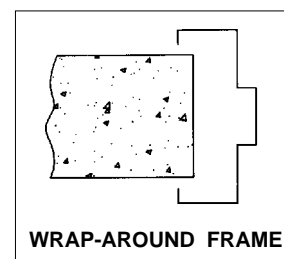
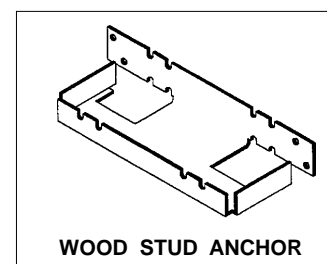
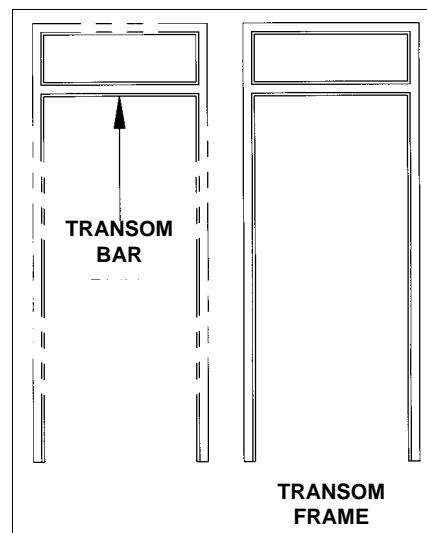
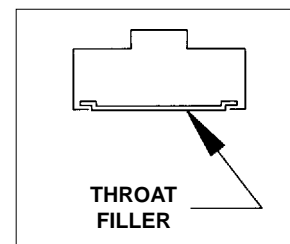
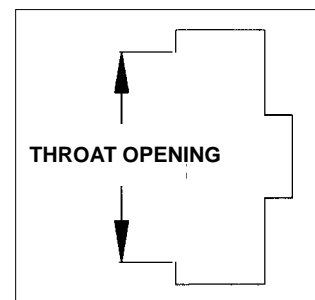

# DOOR AND FRAME HANDING CHART

**How to determine hand of door and frame**  
**Hand all doors by standing outside on key side — facing door**

**SINGLE DOORS:**

When door swings to outside and hinges are on right side of door:  
 Door is R.H.R.B.—Frame is L.H.

When door swings to inside and hinges are on right side of door:  
 Door is R.H.—Frame is R.H.

**SINGLE DOORS:**

When door leaves swing to outside and hinges are on right side of active leaf:  
 Door is R.H.R.B. Active—Frame is L.H. Active

When door leaves swing to inside and hinges are on right side of active leaf:  
 Door is R.H. Active—Frame is R.H. Active

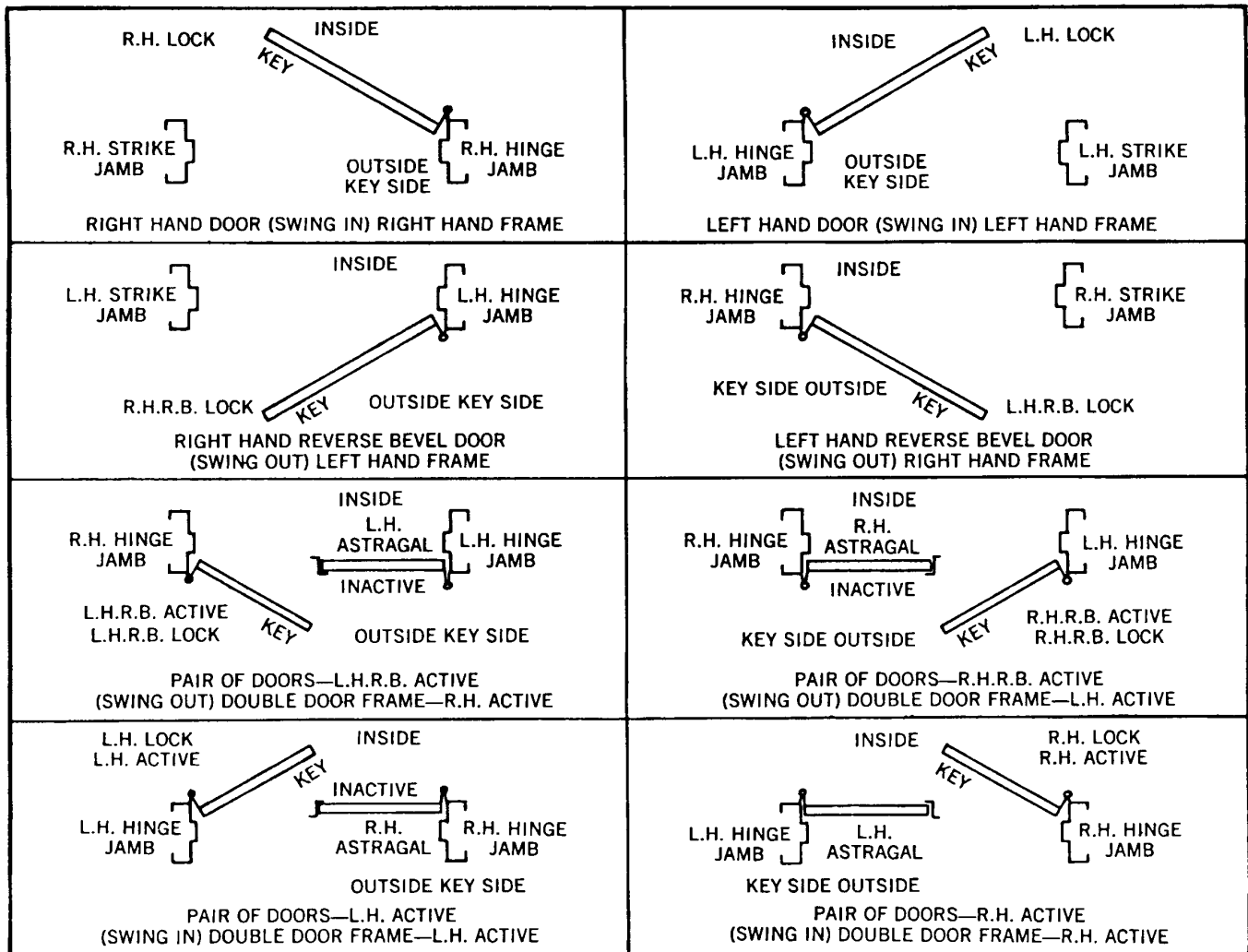

## 2 Steel Doors

### [ACTIVE LEAF]

that leaf or both leaves of a pair of doors for which the locking or latching mechanism or other operating hardware are intended

### [AIR CONDITIONING GRILLE]

see *grille or inserted grille*

### [ASTRAGAL (OVERLAPPING OR WRAP-AROUND)]

a vertical moulding attached to the meeting edge of one leaf of a pair of doors for protection against weather conditions, to minimize the passage of light between the doors and/or to retard the passage of smoke, flame or gases during a fire—may be prepared for mortised hardware in lieu of door preparation

### [ASTRAGAL (SPLIT)]

a pair of vertical mouldings attached to both leaves of a pair of doors at the meeting edges for protection against weather conditions—can be used when both leaves are active

### [BEVELED EDGE]

the edge of a door which is not at a 90 degree angle to the face of the door (standard bevel is 1/8 inch in 2 inches)—narrow side of door is side in contact with stop of frame when door is closed

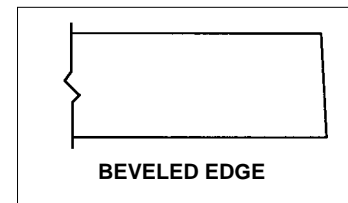

### [BEVELED SQUARE EDGE]

the edge of a door which is at a 90 degree angle to the face across that portion required for lock mortising—the corners are beveled for clearance in swinging

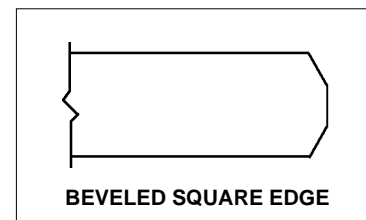

### [BOTTOM RAIL]

horizontal member at the bottom of door connecting lock stile with the hinge stile—may be integral with face

### [CENTER PANEL]

portion of door between hinge and lock stile

### [CENTER RAIL (MID-RAIL)]

horizontal member in door usually located at lock height used to separate upper and lower lites or panels—may be integral with face

### [CLOSER REINFORCING]

reinforcing in door to provide additional strength for attachment of door closers—does not include drilling and tapping of mounting holes

### [COMPOSITE DOOR]

a door consisting of a solid core bonded to a metal facing

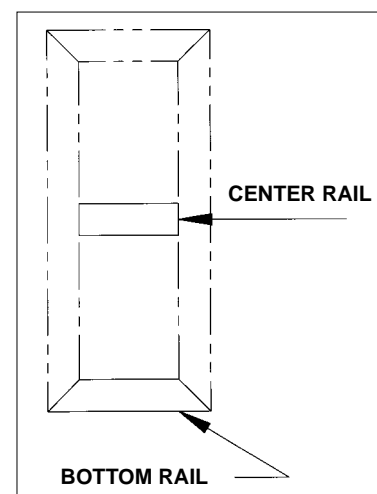

**ANSI A250.7-1997**

**[CONTINUOUS WELD/CONTINUOUS WELDED DOOR]**

weld along vertical door edge seam which is unbroken along its entire length except at hardware cutouts or mortises

**[CORE]**

internal construction in a steel door

**[CUTOUT]**

a piercing for hardware, lite, louvers, and/or accessories

**[CYLINDRICAL LOCK PREPARATION]**

see ANSI/DHI A 115.2 and A115.18 for data<sup>(1)</sup>

**[DOOR CLEARANCE]**

the space between door and frame rabbet, between door and finished floor, or between meeting edges of pairs of doors

**[DOOR DESIGNS]**

see pg. 21

**[DOUBLE ACTING DOOR]**

type of door prepared for pivot or spring type hinge permitting the door to swing 90 degrees in either direction

**[DUTCH DOOR (DESIGN D)]**

a door having two separate leaves, hung one over the other, usually equipped so that both leaves can be operated independently—lower leaf frequently has a service shelf

**[EMBOSSSED PANEL DOOR]**

a door design incorporating decorative panels formed or embossed into door faces

**[END CAP]**

piece used to provide flush condition for doors with recessed top and bottom

**[END CHANNEL (CLOSURE)]**

horizontal channel welded into top and bottom of doors for strength and rigidity

**[FACE]**

surface of door exposed to view when closed

**[FILLER PLATE]**

a blank plate used to fill mortised cutouts

**[FLOOR CLEARANCE (UNDERCUT)]**

clearance between bottom of frame and bottom of door—The floor clearance may not be the same as the clearance between the bottom of the door and the finished floor—the floor clearance can only be determined after the finished floor material is in place

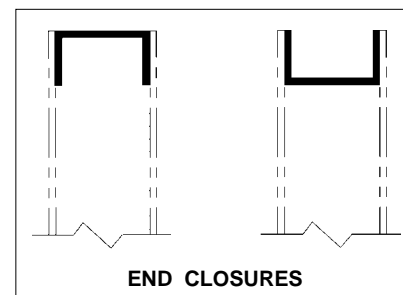
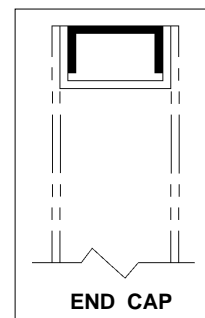
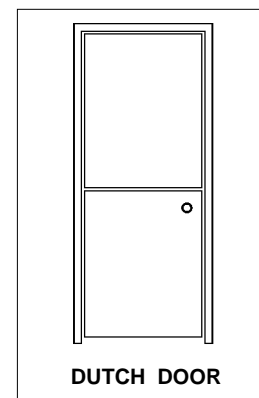
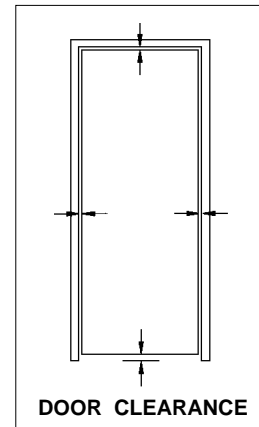

(1) Available from the Door and Hardware Institute, 14170 Newbrook Drive, Chantilly, VA 22021

**[FLOOR TO CEILING UNIT]**

an assembly with door and fixed panel above—no transom bar between—design of panel makes it appear to be extension of door

**[FLUSH DOOR (DESIGN F)]**

a door without glass lite and/or louvers

**[FLUSH PANEL TYPE DOOR (STILE & PANEL CONST.)]**

a model of door consisting of one center panel and one lock stile and one hinge stile—stiles are butted to and interlock with panels—an archaic construction method

**[FLUSH PANEL TYPE DOOR (STILE & RAIL CONST.)]**

a model of door using stiles and rails either mitered or butted, the corner joints being welded and ground smooth—panels interlock with the stiles and rails and are stiffened by internal reinforcing—joint lines between the panels, stiles and rails may be left visible—surface of panels and stiles lie in a parallel plane—the panels may be recessed an amount equal to the thickness of the stile metal

**[FREE AIR AREA]**

expressed as a percent ratio of actual air passage area to louver or grille total area—higher percentage indicates greater air transfer capacity

**[FULL FLUSH DOOR]**

a design of door formed from two sheets of metal—top and bottom of the door may be either flush, or closed with recessed channel end closures—seams are visible on door edge only

**[FULL GLASS DOOR (DESIGN FG)]**

a design of door having glass the entire height and width of the area surrounded by rails and stiles—door may have horizontal muntins dividing up the glass area—stiles and rails may be integral with faces

**[FULL LOUVERED DOOR (DESIGN FL)]**

a design of door having louvers the entire height and width of the area surrounded by rails and stiles—stiles and rails may be integral with faces

**[GLASS STOP]**

fixed trim on a glass lite door against which glass is set

**[GLAZING BEAD]**

removable trim on a glass lite door that holds glass firmly in place

**[GLAZING MOULDING]**

see *glass stop*

**[GRILLE]**

an inserted unit made up of a series of fins or a perforated plate to allow the passage of air through the door—usually greater free air area than a louver

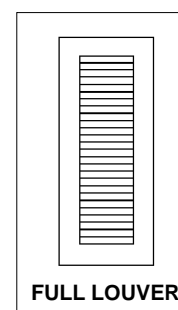
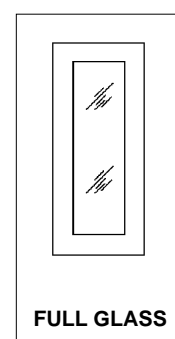
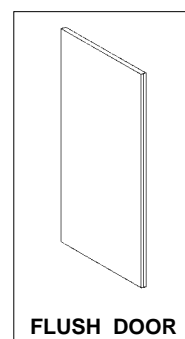
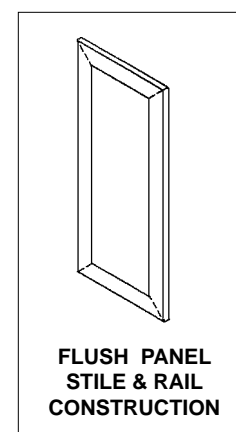
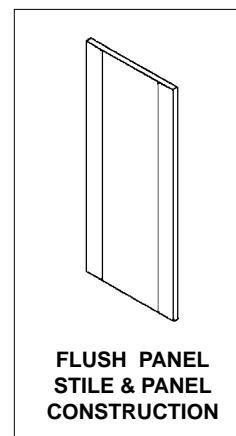

**[HALF GLASS DOOR (DESIGN G)]**

a design of door having glass in upper portion only

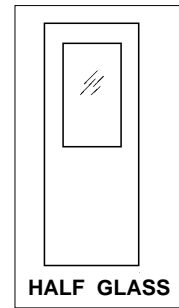

**[HANDING]**

the swing of the door, e.g., right hand or left hand. To determine the hand of a door, view the door from the outside—the side that the hinges are on is the hand of the door—if the door swings away from the viewer, the hand is a regular hand, i.e., right or left hand—if the door swings to the viewer, the door is reverse swing, i.e., right hand reverse swing or left hand reverse swing

**[HINGE BACKSET]**

distance from edge of hinge to stop side of door

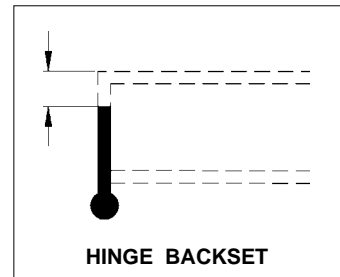

**[HINGE FILLER]**

small removable trim part located between hinge leaf and hinge reinforcements—its position can be reversed to accommodate change of door handing

**[HINGE REINFORCEMENT]**

structure to which hinge is attached—used to provide additional strength at preparation for hinge application to the door

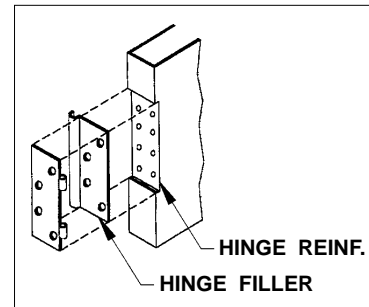

**[HINGE SIDE (FACE)]**

that face of a door viewed when observing the hinge knuckles on the door and frame—an aid in handing door or noting security side of glass bead or inserted louvers—see "*wide side*"

**[HINGE STILE] [HINGE EDGE]**

vertical member of a door prepared for installation of hinge

**[HORIZONTAL MUNTIN]**

member used to divide glass panels horizontally—see *muntin*

**[INACTIVE LEAF]**

the door leaf in a pair of doors which is normally held closed by top and bottom bolts

**[INSERTED GRILLE]**

grille that is fabricated separately and inserted into a preparation in the door

**[INSERTED LOUVER]**

louver that is fabricated separately and inserted into a preparation in the door



**[KEY SIDE]**

reference point used to determine outside of door—sometimes required for handing or determination of secure side of glass bead or louvers

**[LABELED DOORS (CLASSIFIED DOORS)]**

door that conforms to all applicable requirements and procedures of governing labeling authority and bears their identification label or mark

**[LEAF]**

an individual door, used either singly or in multiples

**[LITE]**

preparation in a door for view window, vision and/or glazing including glass stop and glazing bead

**[LOCK BACKSET]**

distance from centerline of lock front to centerline of function holes measured at mid-point of door thickness

**[LOCK EDGE]**

that vertical edge of a swing door which is opposite the hinge edge; same as Leading Edge or Strike Edge

**[LOCK REINFORCEMENT]**

Structure to which lock is attached—used to provide additional strength at preparation for lock in door

**[LOCK STILE] [LOCK EDGE]**

vertical member of a door prepared for installation of lock

**[LOUVER]**

an opening in the door with a series of slats or blades to allow passage of air—see **SDI 111-C**

**[LOUVER (AUTOMATIC)]**

an opening in the door with a series of slats or blades to allow passage of air, designed to close automatically in the event of fire

**[LOUVER (FUSIBLE LINK)]**

see *louver (automatic)*

**[LOUVERED DOOR (DESIGN L, LL, or TL)]**

door design with one or more louvers

**[MEETING STILE]**

vertical lock or strike edge of a double door adjacent to the opposite door

**[MORTISE]**

a recess in the door on a minimum of 3 sides of the hardware item closely surrounding the contour of the item allowing its faceplate to finish flush with the door surface

**[MORTISE LOCK PREPARATION]**

see ANSI/DHI A115.1 for detailed data<sup>(1)</sup>

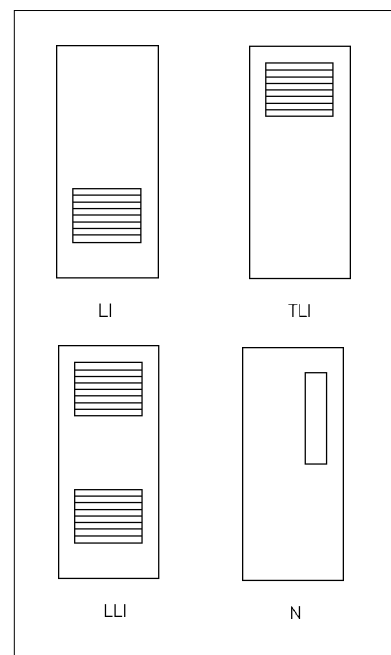
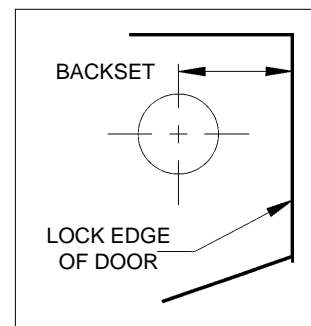

**[MUNTIN]**

formed member used to subdivide glass area in door

**[NARROW LITE DOOR (DESIGN N)]**

design of door with narrow rectangular lite at lock stile of door

**[NARROW SIDE (OF DOOR)]**

That face of the beveled edge door which contacts the frame stops—see *stop side*

**[PANEL INSERT]**

a metal panel usually used to convert a stile and rail type door to a flush or half glass type door

**[PIERCED LOUVER (DESIGN LP)]**

louver that is formed into the face sheets or panels of the door

**[POCKET DOOR]**

a door that is prepared to slide into a pocket built in the wall

**[PUNCHED LOUVER (DESIGN LP)]**

see *pierced louver*

**[RECESS PANEL TYPE DOOR (STILES & RAILS)]**

a model of door using stiles and rails either mitered or butted—mitered joints are welded and ground smooth at the corners and butted joints are horizontally stiffened with U-shaped end closures—unmitered joints may be left visible—the recessed panels interlock with the stiles and consist of a metal face with a resilient separator—panels are nominally 3/8 inch thick

**[REINFORCING CHANNEL]**

see *end channel*

**[REVEAL (DOOR)]**

the distance from the face of the door to the face of the frame on the hinge or wide side

**[REVERSE BEVEL]**

refers to hand of door or lock on outswing doors

**[REVERSE SWING]**

see *reverse bevel*

**[SEAMLESS DOOR]**

a model of door formed from two sheets of steel. No exposed seams shall occur on the door face or vertical edge—the top and/or bottom of the door shall either be closed with a recessed channel end closure or shall receive a flush end closure treatment

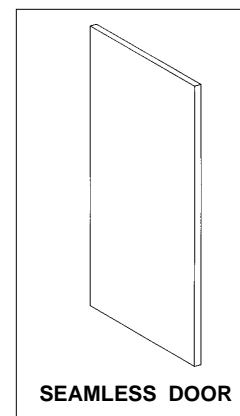
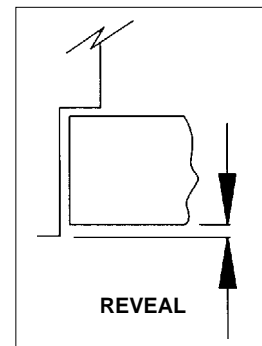
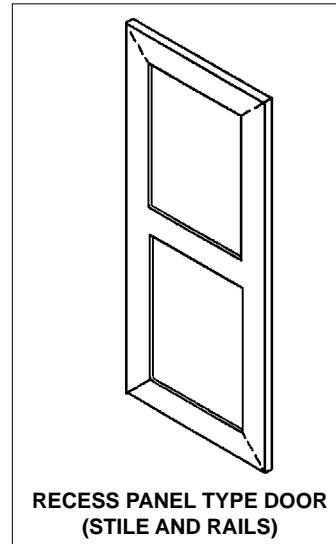

**[SINGLE ACTING DOOR]**

type of door prepared for a pivot type or spring type single-acting hinge permitting the door to swing in one direction only

**[SOUND RATED DOOR]**

a door with a published performance rating used for the reduction of sound through an opening—normally includes frame and gasketing supplied as a unit

**[SPLIT ASTRAGAL]**

see *astragal (split)*

**[SQUARE EDGE DOOR]**

unit with edges 90 degrees to its face

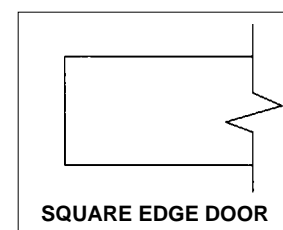
**[STAMPED LOUVER (DESIGN LP)]**

see *pierced louver*

**[STAMPED LOUVER PLATE]**

Formed sheets, surface applied over a prepared opening in door panels

**[STIFFENER]**

Internal steel reinforcing used to strengthen door panels

**[STILE & RAIL]**

a model of door using stiles and rails either mitered or butted—corner joints welded and ground smooth—panel interlocks with stiles and rails and is provided with core or stiffeners—panel may be flush with (flush panel door) or recessed (recessed panel door) from faces of stiles and rails

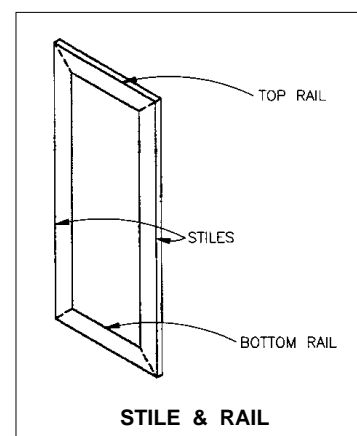
**[STRIKE REINFORCING]**

structure to which strike is attached—used to provide additional strength at preparation for strike in inactive leaf door

**[STOP SIDE (FACE)]**

that side of a door viewed when observing the stop of the frame—an aid in handing door or noting security side of glass bead or inserted louvers—see "Narrow Side"

**[STRIKE STILE]**

vertical member of an inactive door leaf which receives the strike

**[SURFACE HARDWARE PREPARATION]**

in plant reinforcing for field applied hardware mounted to door face surfaces or mounted to surface of top or bottom end channels—does not include drilling and tapping of mounting holes

**[SWING]**

indicates hinged stile of door when keyed and viewed from stop side—e.g. right hand swing door is hinged on right side

**[TEMPERATURE RISE DOOR]**

fire door that has a rating determined by the amount of heat passing through the door for the first 30 minutes of a fire test

**[TEMPLATE]**

a precise detailed layout or pattern for providing the necessary preparation of a door or frame to receive hardware

**[TOP AND BOTTOM CAP]**

see *end cap*

**[TOP RAIL]**

horizontal rail at the top of door connecting lock stile with the hinge stile

**[UNDERCUT]**

see *floor clearance*

**[VERTICAL MUNTIN]**

member used to divide glass panels vertically

**[VERTICAL VISION LITE DOOR (DESIGN N)]**

see *narrow lite door*

**[VISION LITE DOOR (DESIGN V)]**

design of door having one small view window in upper portion only, usually square design on vertical center line of door

**[WIDE SIDE (OF DOOR)]**

that face of the beveled edge door opposite that which contacts the frame stops—see *hinge side*

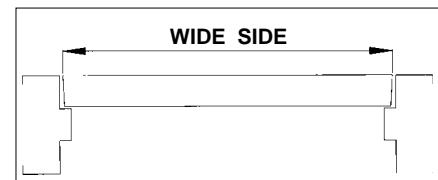
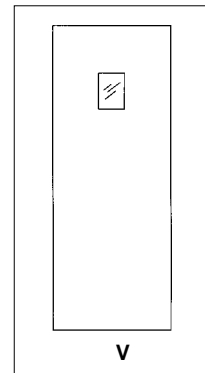
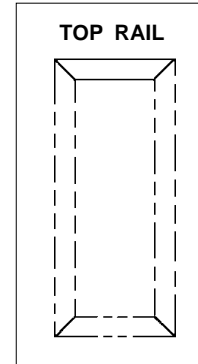

## NOMENCLATURE FOR STANDARD DOOR DESIGNS

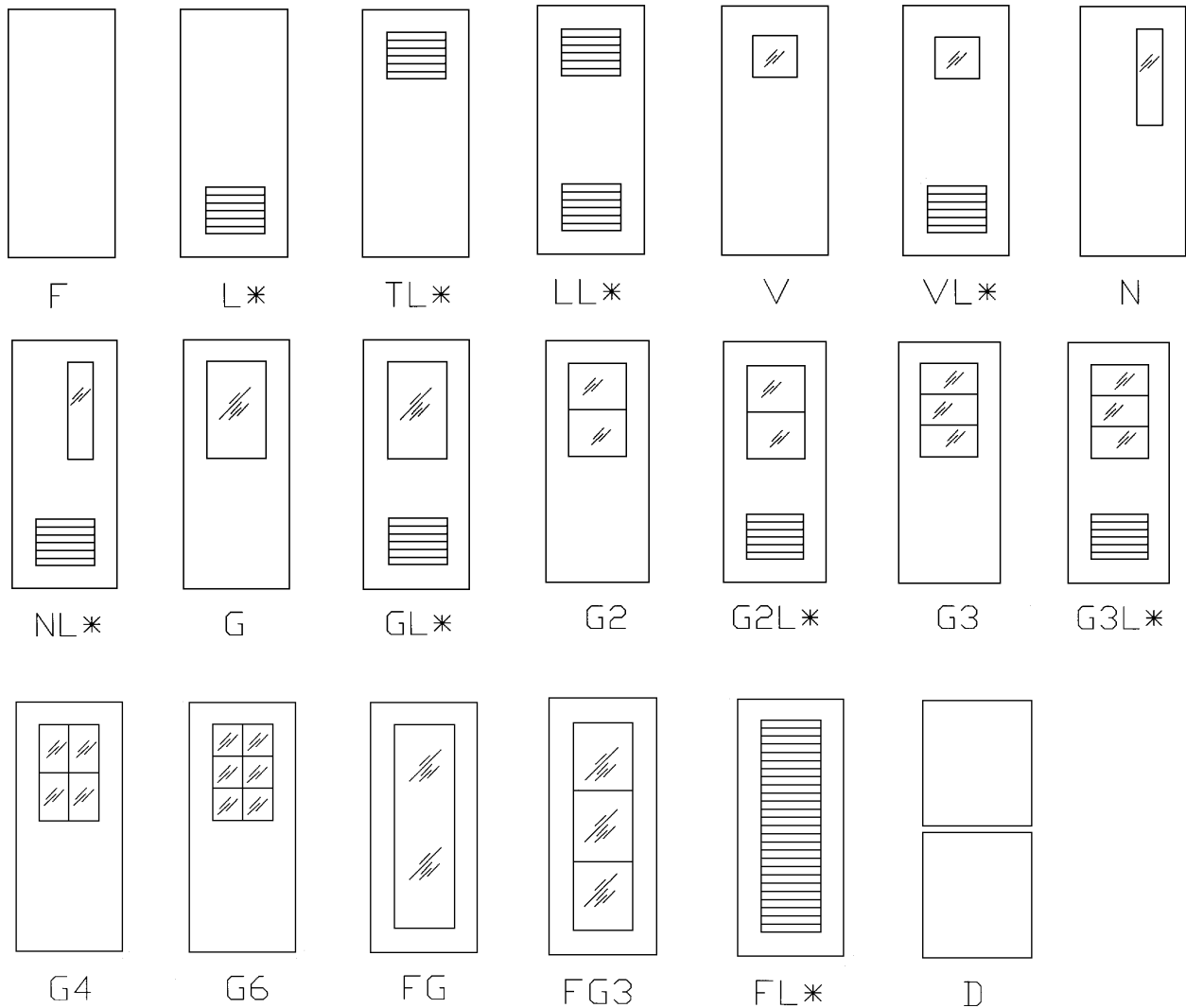

### NOMENCLATURE LETTER SYMBOLS

<b>F</b> — Flush	<b>NL*</b> — Narrow Lite and Louvered
<b>L*</b> — Louvered (bottom)	<b>G</b> — Half Glass (options G2, G3, G4, G6)
<b>TL*</b> — Louvered (top)	<b>GL*</b> — Half Glass and Louvered (options G2L*, G3L*)
<b>LL*</b> — Louvered (top and bottom)	<b>FG</b> — Full Glass (option FG3)
<b>V</b> — Vision Lite	<b>FL*</b> — Full Louver
<b>VL*</b> — Vision Lite and Louvered	<b>D</b> — Dutch Door
<b>N</b> — Narrow Lite	

\*Louvered door designs; specify design, louver size and/or free area requirements.

ADD SUFFIX "I" TO INDICATE INSERTED LOUVER  
 ADD SUFFIX "P" TO INDICATE PUNCHED LOUVER  
 ADD SUFFIX "A" TO INDICATE AIR CONDITIONING GRILL